

FSA

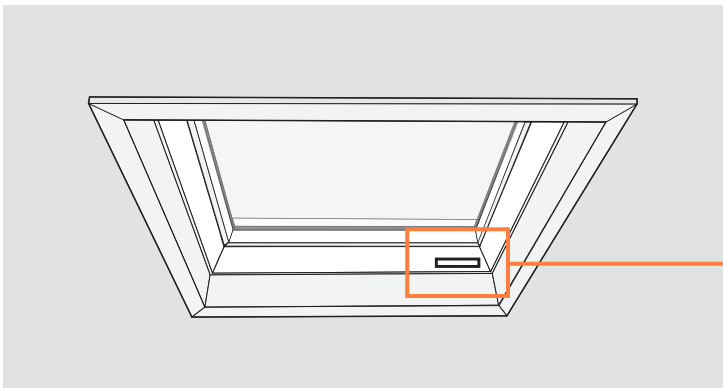

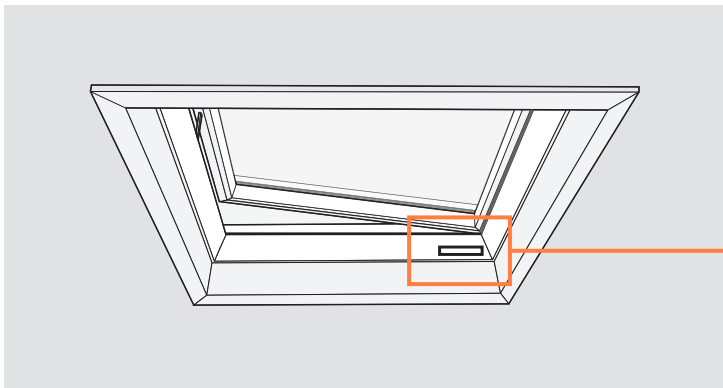

FRE

EN 1873:2005
CE 12
FRE XXXXXX XXXXXX
EN 1873:2005 ic XXXXXXXX



4-16

FRF

EN 1873:2005
CE 12
FRF XXXXXX XXXXXX
EN 1873:2005 ic XXXXXXXX



17-27

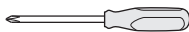
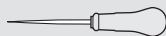
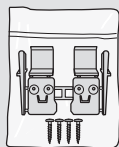
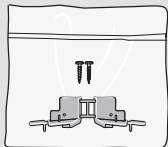
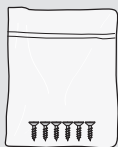
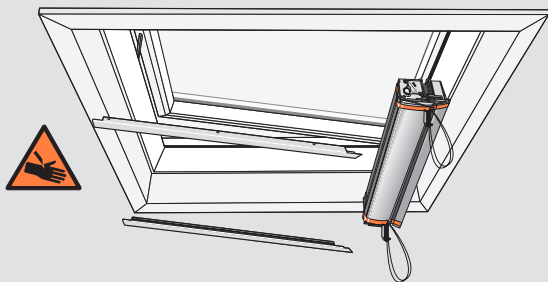

1

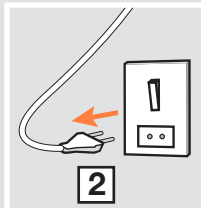
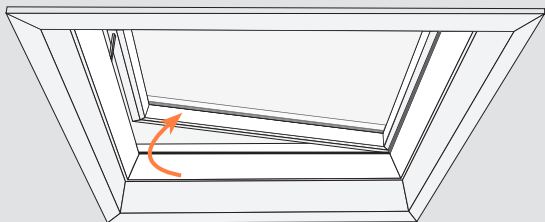

2

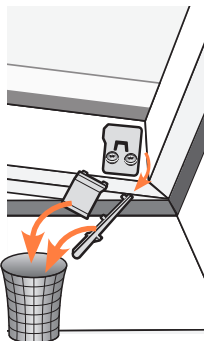
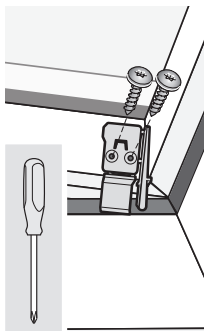
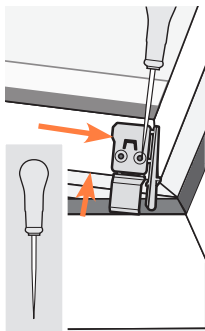
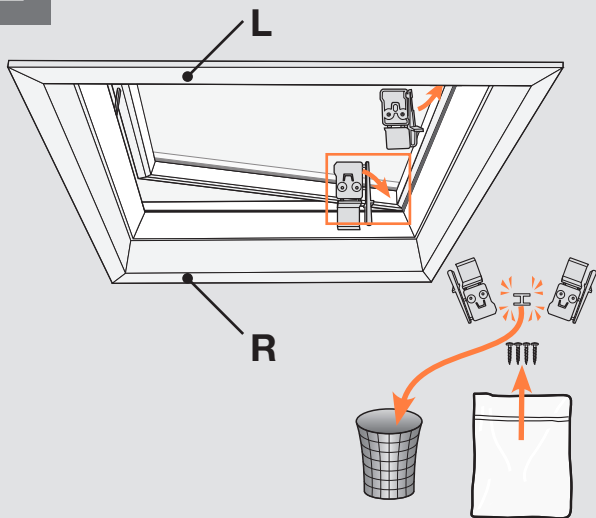

3

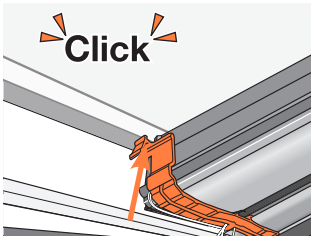
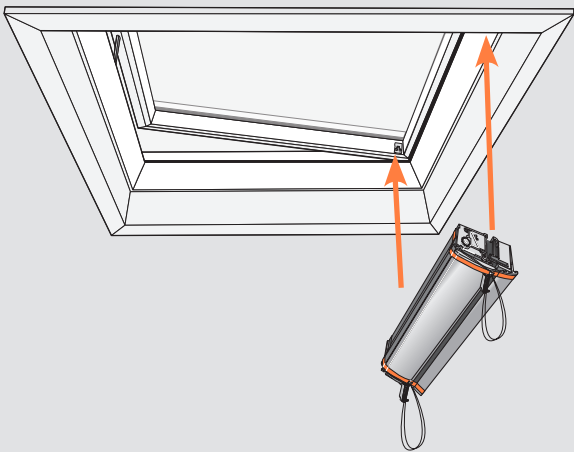

4

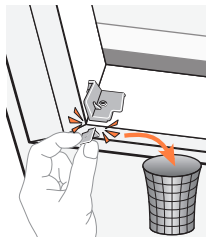
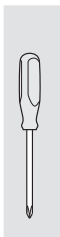
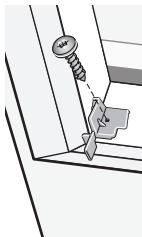
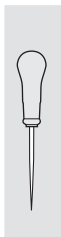
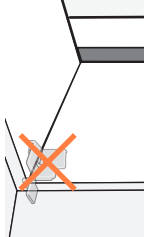
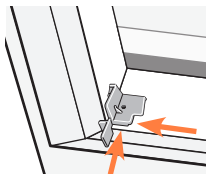
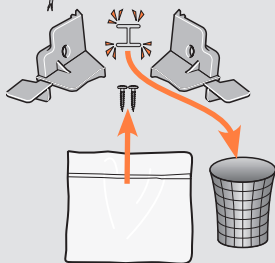
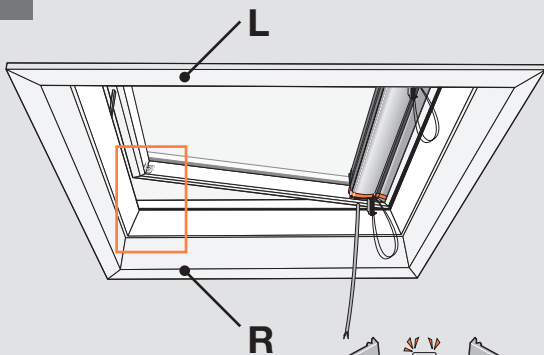

5

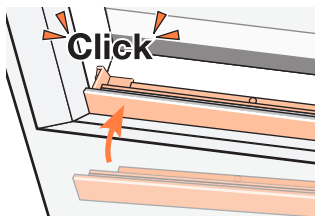
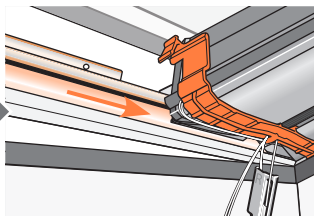
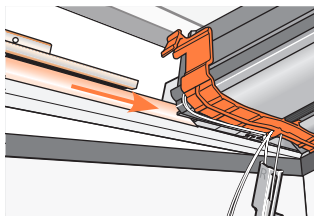
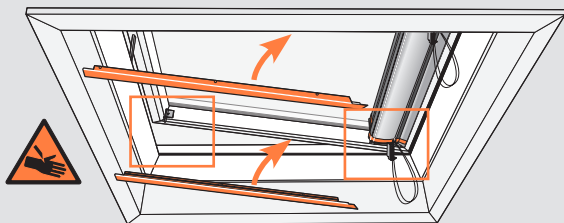

6

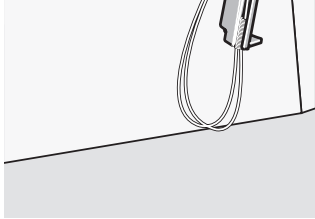
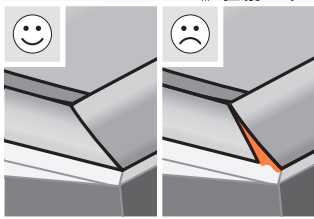
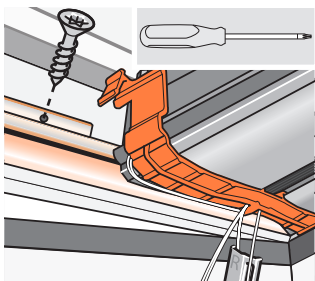
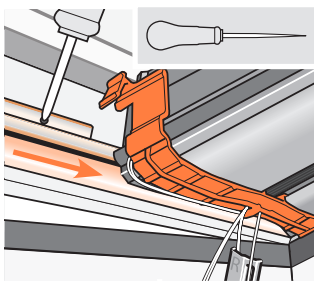
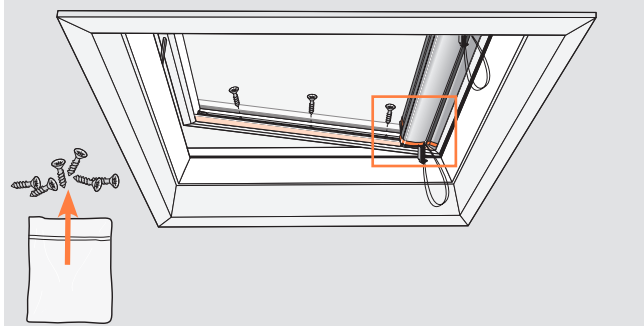

7

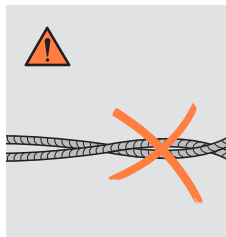
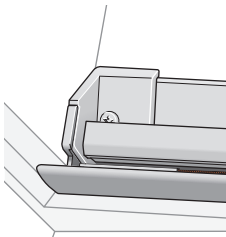
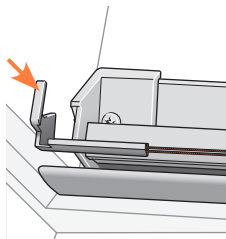
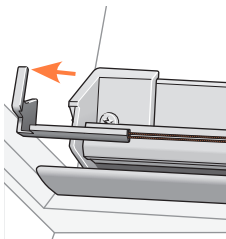
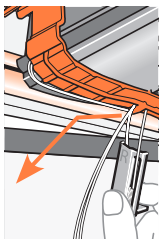
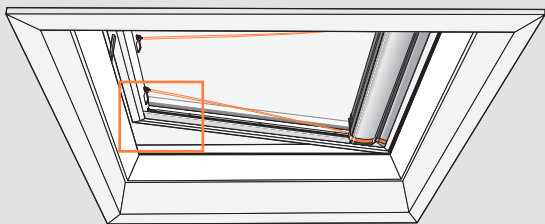

8

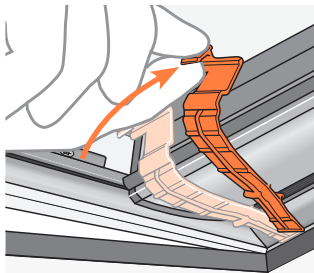
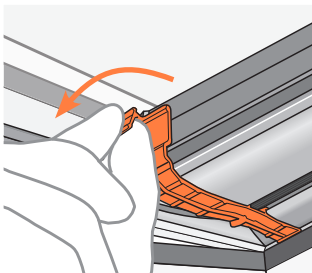
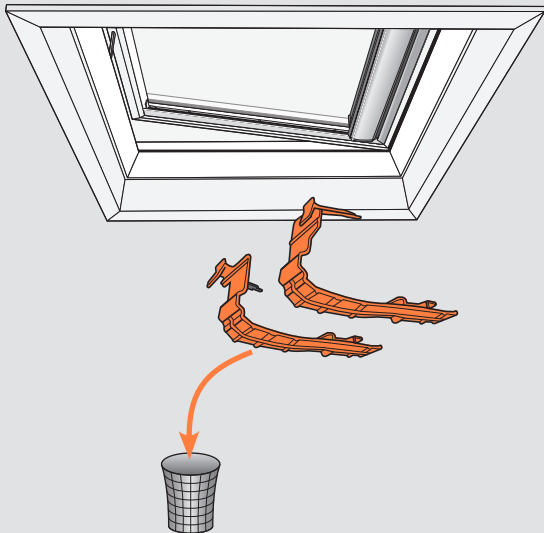

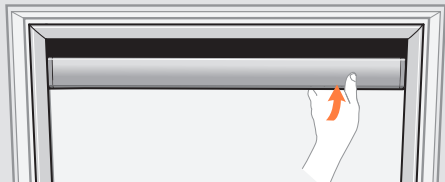
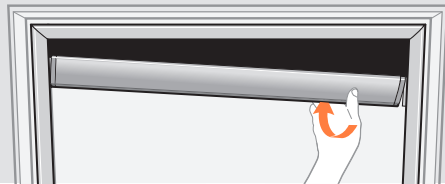
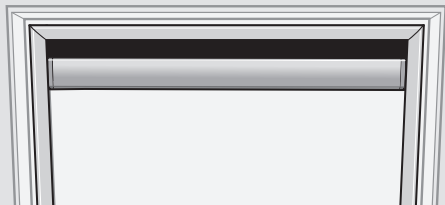

9

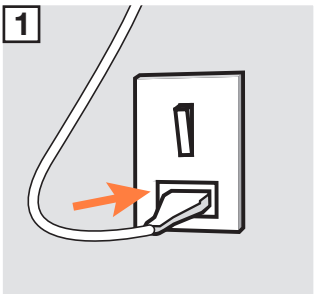
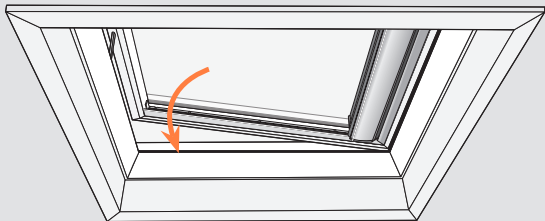

10

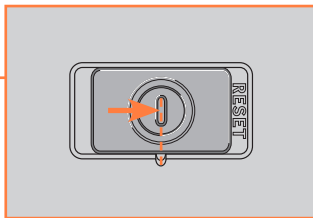
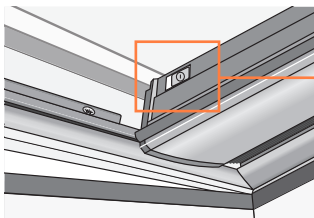
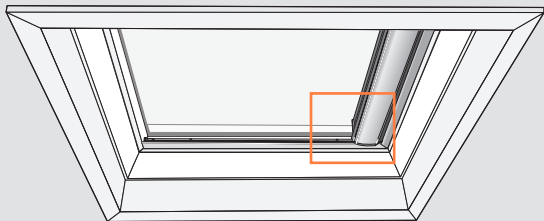

11

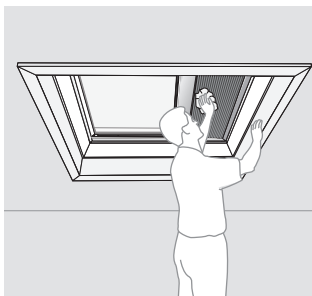
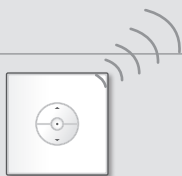
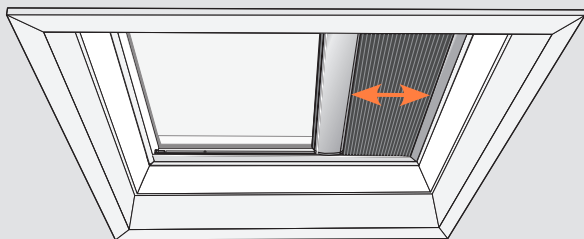

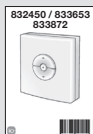
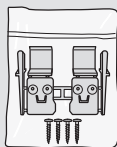
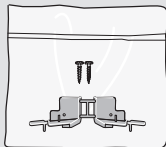
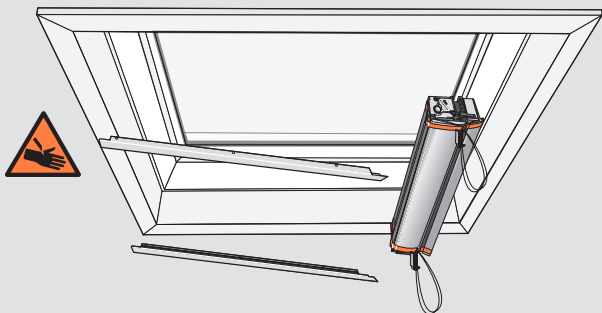

1

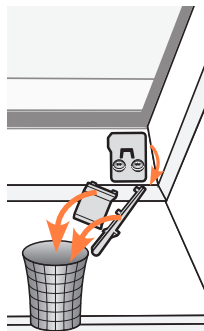
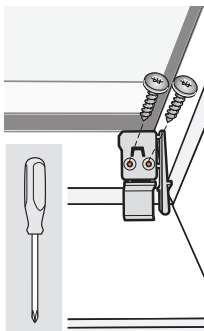
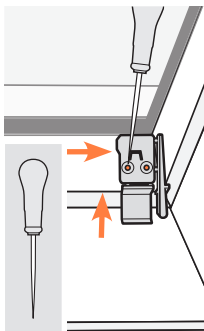
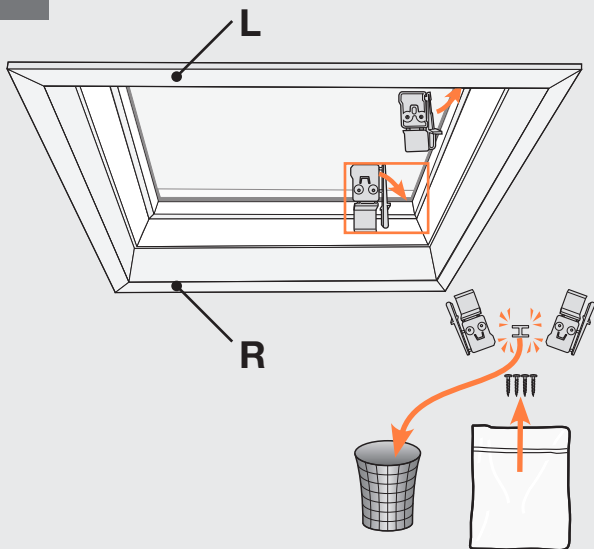

2

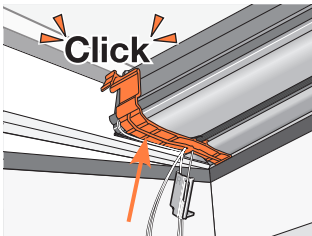
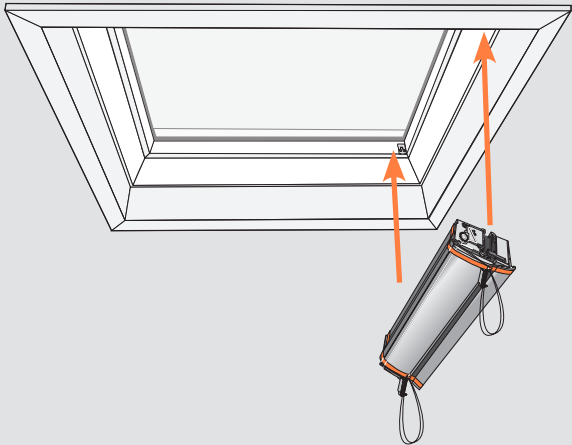

3

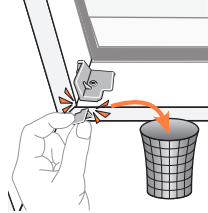
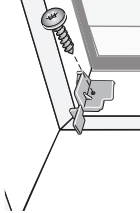
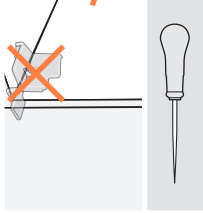
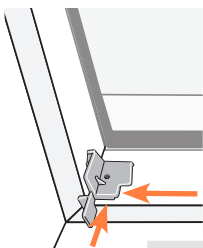
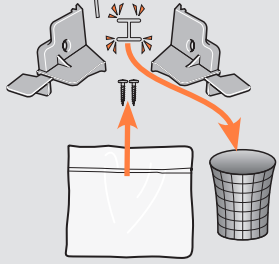
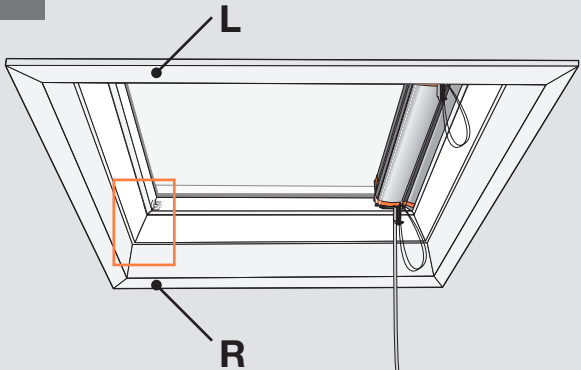

4

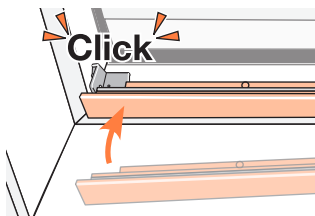
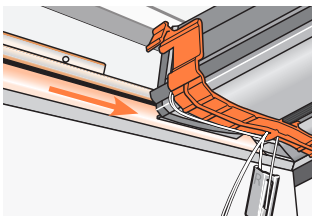
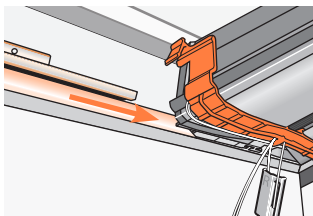
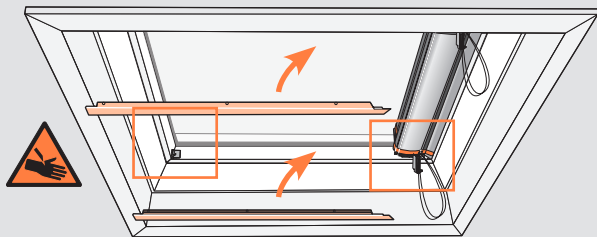

5

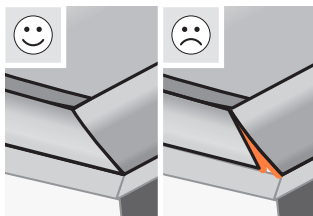
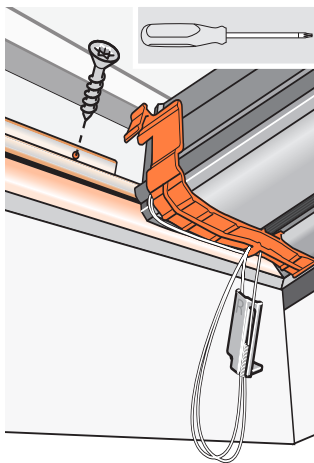
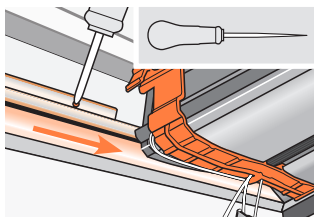
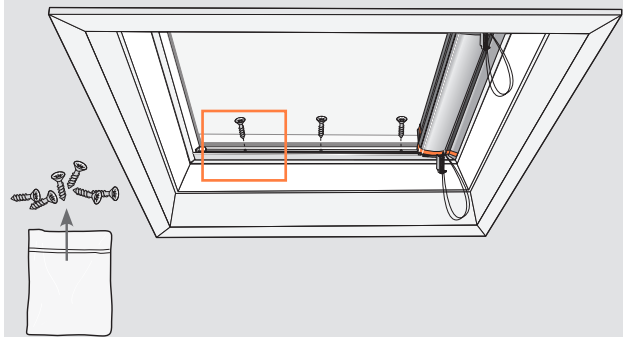

6

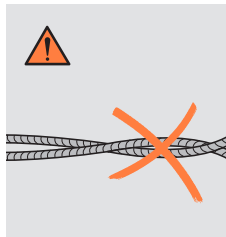
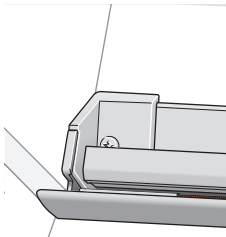
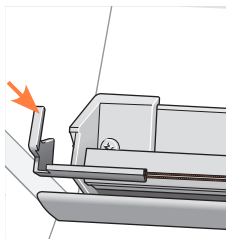
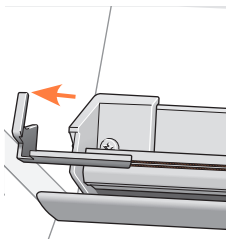
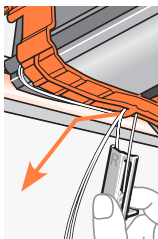
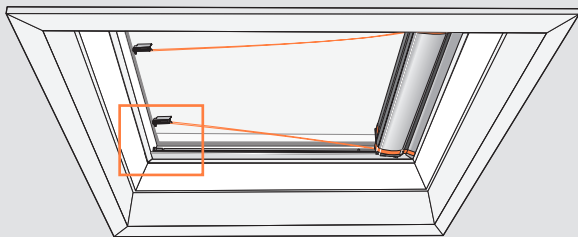

7

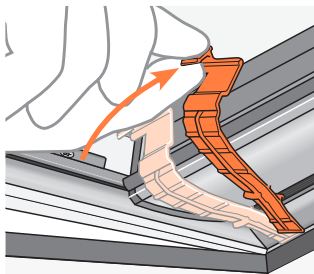
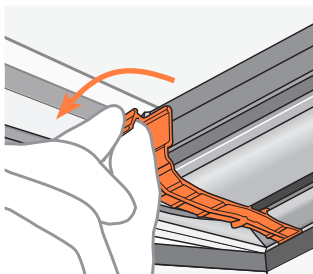
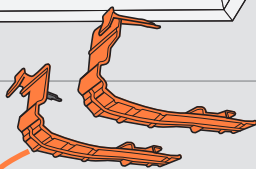
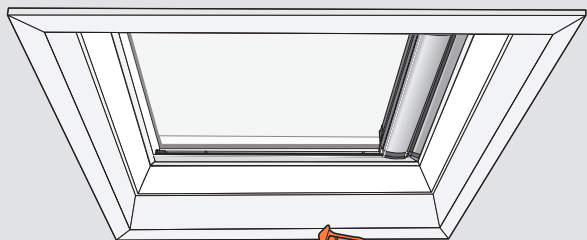

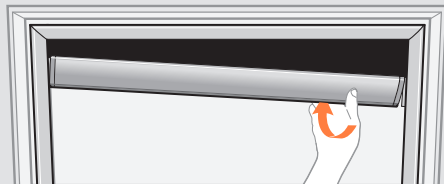
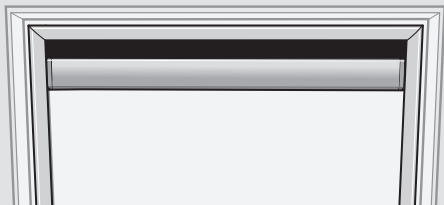

8

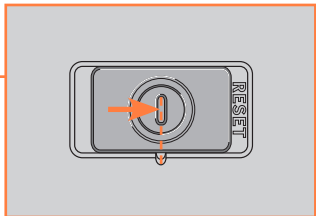
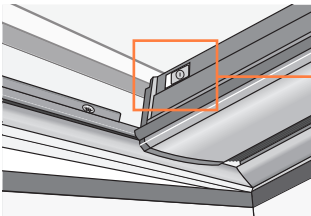
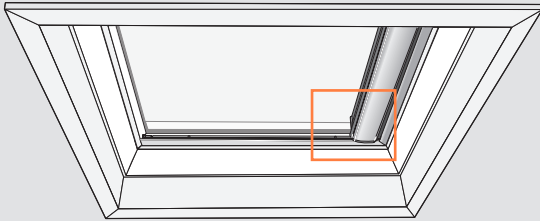

9

